

Smart Roll Banner (Single Sided)



Smart Roll Banner; With the latest revision on Smart Roll Banner, M&T concentrated on both design and outlook features of the product&functionality. Pipe fixation addition, improved end caps provide a more stable product and the new revised design gives a more elegant look to the product. The aluminum body is silver anodised, stands at min 1000 mm, max 2300 mm high, has a unique telescopic pipe.

Smart Roll Banner, mit der letzten Produktverbesserung an dem Smart Rollbanner, hat sich M&T mehr auf Design optische Verbesserungen des Produktes und der Funktionalität fokussiert. Die zusätzliche Verbesserung am Teleskoprohr, verbesserte Endkappen verleihen dem Produkt eine gewisse Stabilität und durch das neue Design ersticht der Smart Rollbanner in einem eleganten und dezenten Design. Das Aluminiumgehäuse ist silber eloxiert, min. 1000mm und max. 2300mm ist mittels dem einzigartigen Teleskoprohr möglich.

Product comes ready to roll-up included into black carry bag
Der Artikel wird einsatzbereit in einer Transporttasche geliefert.

Has unique adjustable telescopic pipe.
Das Produkt hat ein einzigartiges, einstellbares Teleskoprohr.

Please do not loosen the mechanism when the printing is assembled on the top position.
Den Aufrollmechanismus auf keinem Fall in aufgespanntem Zustand des Posters entriegeln.



Improved design



Stable pipe fixation

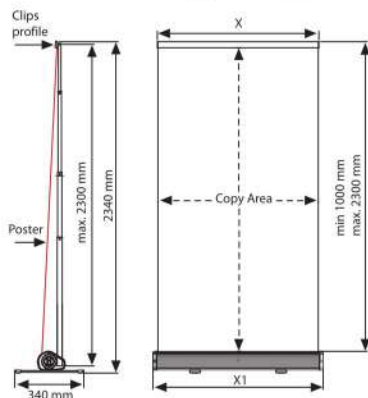

Telescopic Pipe

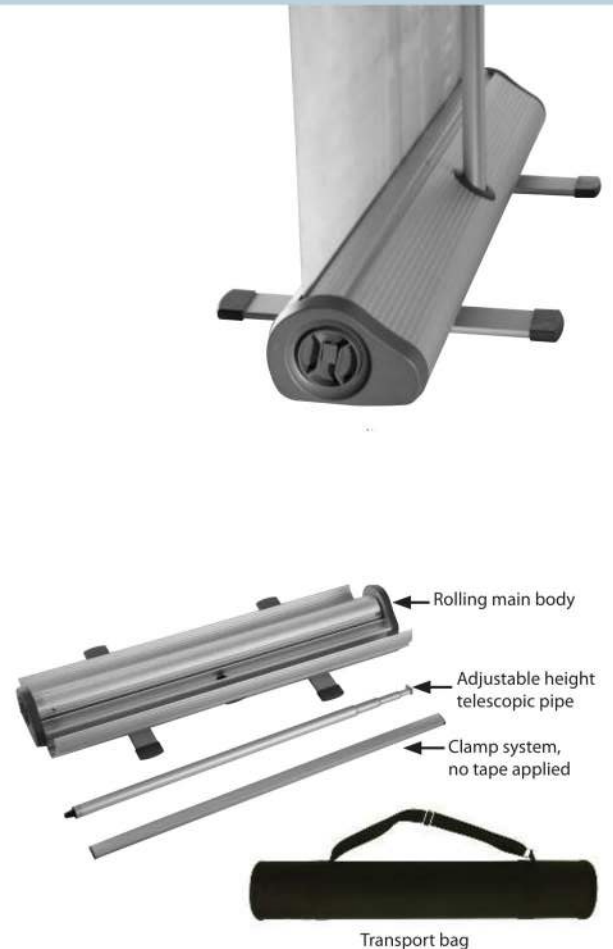
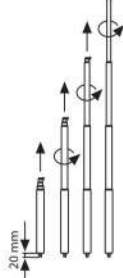

MATERIAL : Silver anodised aluminium		WEIGHT	PACKING SIZE
X1	POSTER	WITH PACKING	*W X H X D
850 mm	800 mm	6,600 kg	180 X 910 X 180 mm
950 mm	900 mm	7,200 kg	180 X 1120 X 180 mm
1050 mm	1000 mm	7,700 kg	180 X 1120 X 180 mm

*W:Width H: Height D: Depth



SMART ROLL BANNER SINGLE SIDED

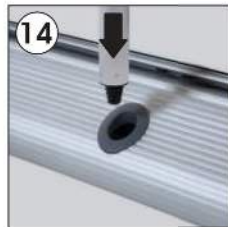
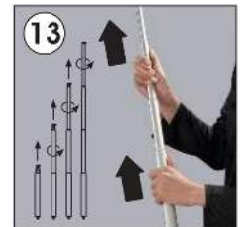
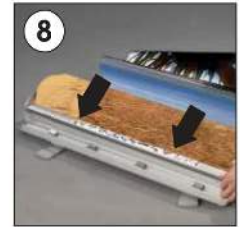
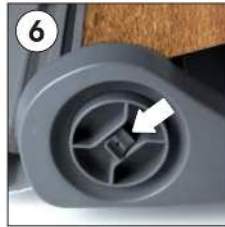
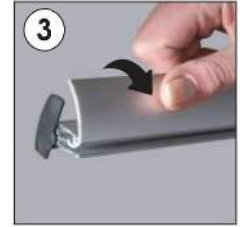
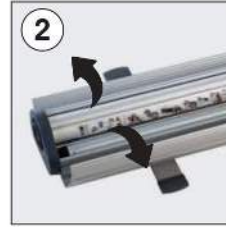

CAUTION!
Please do not loosen the mechanism when the printing is assembled on the top position.



- Please inform the order number on the product or on the carton (e.g. 1/110001394-460) to the place that you have made the purchase if any problem with the product occurs.
- Bitte teilen Sie bei jeglichen Problemen, die auf dem Artikel oder auf der Verpackung aufgeführte Auftragsnummer (z.B. 1/110001394-460) Ihrem Händler mit.
- Lüften unendliche herhangl bir sorun için ürünün veya paketin üzerindeki sipariş numarasını (örnek: 1/110001394-460) satın aldığınız yere bildirin.
- All rights reserved. All pictures, figures and writings are secured internationally by copy-right law. Infringements will be sued by civil and legal law.
- Alle Rechte vorbehalten. Alle Bilder, Zeichnungen und Texte sind international urheberrechtlich geschützt. Etwaige Zuwiderhandlungen werden zivil- und strafrechtlich verfolgt.
- Tüm hakları saklıdır. Tüm resimlerin, şemaların ve yazıların kopya hakları uluslararası kanunlarla güvence altına alınmıştır. İhlali durumunda sivil ve hukuki yasa mercii tarafından dava edilecektir.